



MONARCH[®]

 | 08

DRIVING YOUR DREAM.



MONARCH®

THIS MONARCH RULES.

You don't have to be a king to own the road. Not when you're driving the new 2008 Monarch. This value-priced beauty gives you the royal treatment — with stylish new end caps, full-body paint, your choice of three full-wall slide floorplans, and loads of posh amenities like a 26" LCD TV, a second TV in the bedroom, and new profile raised panel cabinetry. Say, isn't it time you took the throne?



KITCHEN. When it's mealtime, this well-designed kitchen is ready to work. It features a convection microwave, three-burner cooktop, double-door refrigerator, and handy countertop extension on select models.

BEDROOM. Fall into the big queen bed, flip on the 20" color TV (now standard), and you're ready to relax. Other niceties include blackout day/night shades, nightstands, and plenty of clothes storage.

WHAT'S NEW FOR '08.

- Redesigned fiberglass front and rear caps
- Redesigned automotive dash
- 26" LCD TV in front cockpit
- Solid surface kitchen countertops
- Queen bed with nightstand
- New profile raised panel cabinet doors
- China toilet with sprayer
- Now standard: 20" TV in bedroom, full-body paint with vinyl graphics



QUALITY. INNOVATION. HAPPY TRAVELERS. IT ALL SAYS MONACO.

INTERIOR



Wherever you travel across America, it's easy to spot the Monaco owners. They're the ones with the smug, happy grins on their faces. And who could blame them? When you own a Monaco, you own the best. The best in quality, performance, safety, technology and comfort. It's all here. And it's all yours for the taking. Come on, freedom lovers. Make your move to Monaco quality. After all, you already know how to grin.



33SFS | NATURAL CHERRY | REMBRANDT



A DASH OF DISTINCTION.

 PANAVIEW™

1-PIECE WINDSHIELD



MONARCH® COCKPIT/EXTERIOR



Want to add a little distinction to your life? Enter the 2008 Monarch. It's the well-built, affordably priced Monaco coach you've been waiting for. Now with plush leatherette pilot seats. Your choice of Ford or Workhorse chassis. Anti-lock brakes for added safety. And of course, the ergonomically designed dash before you. Care for a little more distinction? You can always opt for Sirius satellite radio and a GPS navigation system.

LIVING AREA. Won't you have a seat? The Monarch offers comfortable furnishings everywhere you look. Note the leatherette swivel rocker (33SFS and 34SBD), easy bed sofa, and leatherette pilot recliner seats — all newly restyled for 2008.

SIDE-SWING BAGGAGE DOORS. For easier access to your belongings, our baggage doors open from the side, not the top. The Monarch also features pass-through storage and one-piece polyethylene boxes for easy washdowns.

NO SEAMS. ADDED SAFETY. With our exclusive Panaview™ 1-Piece Windshield, you get a clear view of the world ahead. There's no annoying black rubber seam running down the middle of the windshield. It's the largest unobstructed view in the industry.



REMBRANDT
NATURAL CHERRY
33SFS





SMARTSTRUCTURE II

SmartStructure II adapts the principles of our diesel chassis technology for use with a gas chassis. While other motorhomes use outriggers to hang the walls and storage compartments, our exclusive truss system is

integrated with the chassis rails to provide a solid platform. The floor and storage bays are all one piece, and the truss system works with the chassis rails to channel weight toward the center of the motorhome. Greater strength. Better weight distribution. A solid foundation. That's SmartStructure II.

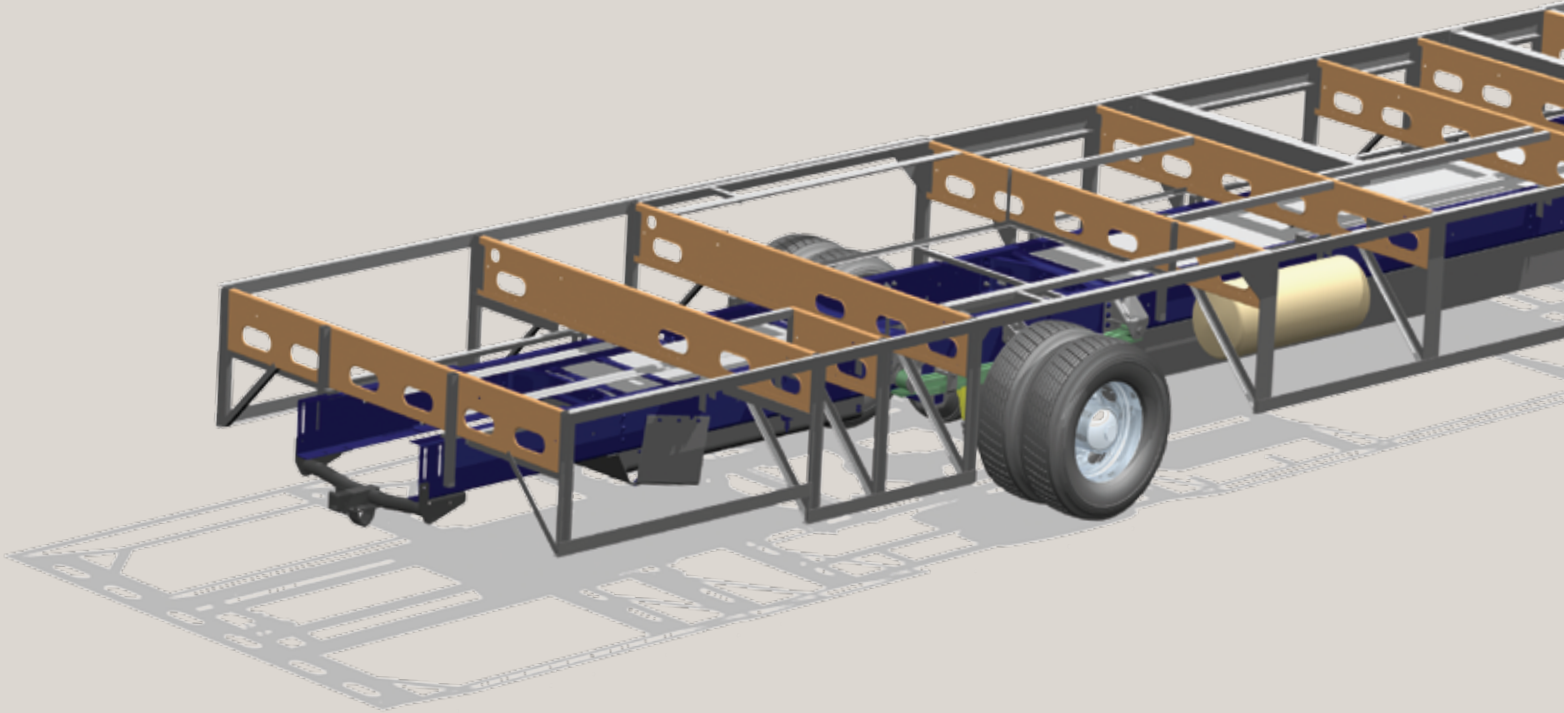

SLIDE-OUT CONSTRUCTION:

When you purchase a Monaco coach, you can be sure the slide-out boxes are some of the strongest and most reliable you'll find anywhere. They feature our exclusive multi-layer construction to give you maximum insulation and to reduce the chance of warping, twisting or shifting.



THE STRENGTH IS IN THE CONSTRUCTION.

Thanks to our Alumaframe® Superstructure, your Monaco coach is built to take on anything the road can dish out. We revolutionized the industry by replacing outdated wood and tubular aluminum construction with our exclusive system of aluminum C-Channel

crossmembers. These run the full length of the coach, with double-welded intersections for superior strength. This makes your Monaco lighter and sturdier than other coaches and gives you reliability you can count on down the road.

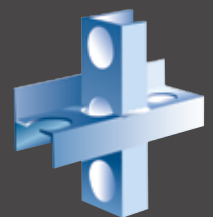

Alumaframe®
(C-Channel)

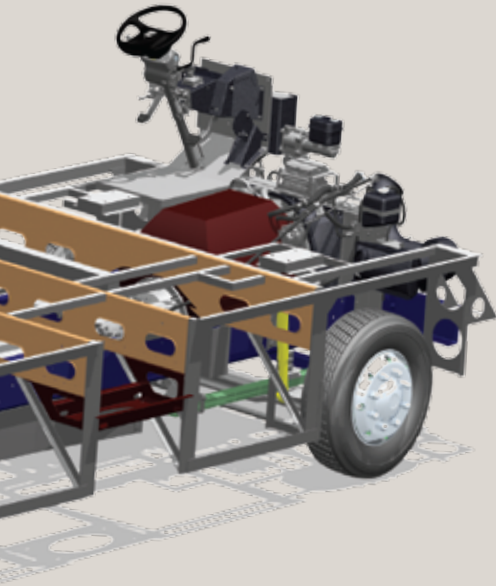

VORTEC™ 8100 ENGINE:

This Workhorse chassis, 8.1L V-8 engine features 340 HP and 455 lbs./ft. torque. The Ford chassis comes standard with a 6.8L 3-valve V-10 engine with 362 HP and 457 lbs./ft. torque.



WARRANTIES

12 MONTH/24,000 MILE basic limited warranty

5 YEAR/50,000 MILE limited warranty on aluminum or steel frame structure of sidewall, roof, front and rear cap

Applies to certain models. See owner's manual for complete details.

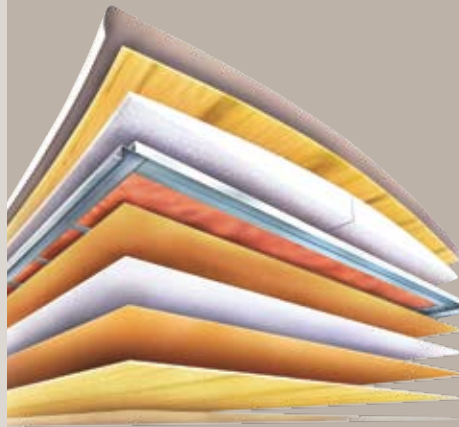

9-LAYER ROOF CONSTRUCTION:
(top to bottom)

- One-piece peaked fiberglass roof
- Luaun backing
- Thick, tapered bead foam insulation
- Aluminum double I-beam superstructure filled with fiberglass insulation
- Vapor barrier
- Structure foam: thermal insulative barrier
- 1/2" bead foam insulation
- Foam padding for extra insulation
- Padded vinyl ceiling

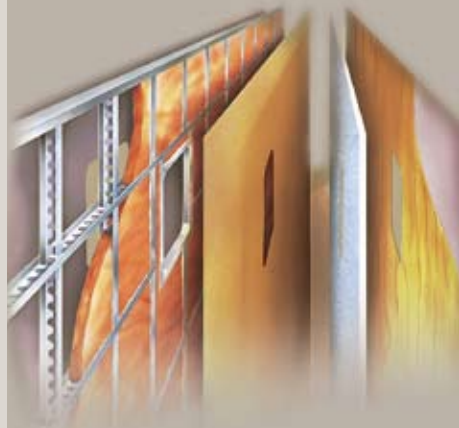

5-LAYER SIDEWALL CONSTRUCTION:
(left to right)

- Smooth gel coat fiberglass
- Interlocking C-Channel filled with 1-1/2" fiberglass insulation bonded in place so it doesn't sag or leave spaces uninsulated
- Vapor barrier
- Bead foam adds comfort, saves energy and provides a thermal insulative barrier
- Interior paneling

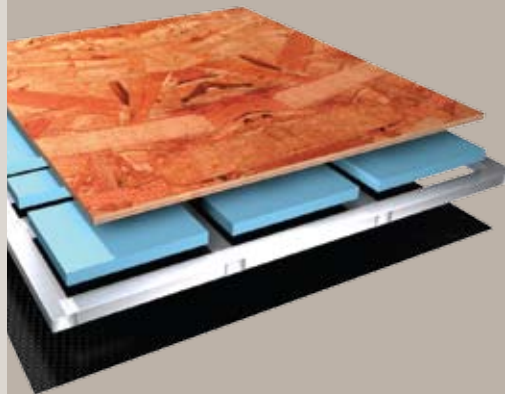

4-LAYER FLOOR CONSTRUCTION:
(top to bottom)

- Structurwood™
- Blue foam insulation
- 1-1/2" aluminum tube
- Three-ply poly underbelly



ASSISTANCE

SALES • TECH • ROADSIDE

1-877-4MONACO

WE'RE HERE. ANYTIME, EVERY TIME.

- Reach us anytime — literally — via our live customer support line.
- Drive in to one of our 350 Service Centers.
- Enjoy the first year free when you enroll in our Owner Advantage Roadside Assistance Program.
- See where it all begins with a tour of one of our facilities in Indiana or Oregon. Call 1-800-650-7337 or 1-800-634-0855 to find out more.

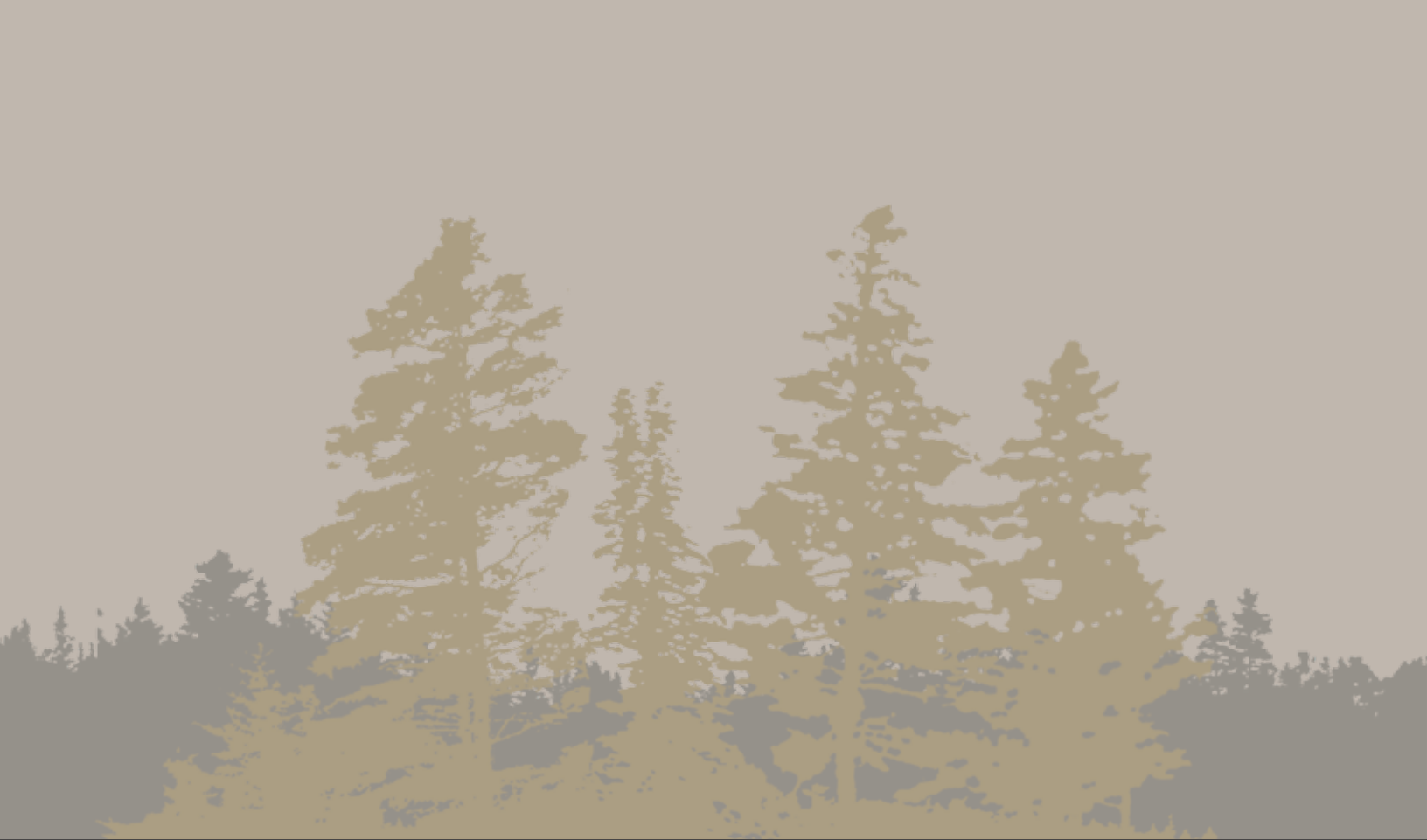

AUTUMN TRAIL

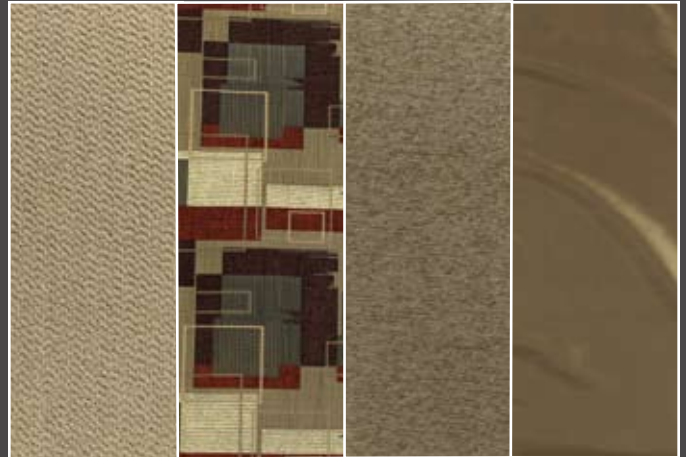



NEWPORT CHERRY



CHAMPAGNE SELECT



WHICH WAY WILL YOU GO?

We know you love choices. That's why our designers give you so many tempting options. From mild to wild, discriminating to daring, Monaco offers lots of fun ways to go.

REMBRANDT



URBAN LOFT



Note: Colors depicted are a reasonable representation though they may not be an exact match of the actual colors due to variances in processing and production. See your dealer for actual fabric and paint chip samples.

- Carpet A
- Dinette B
- Sofa C
- Bedspread D

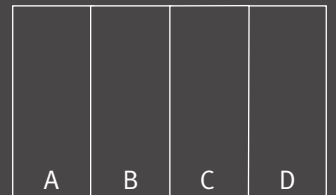

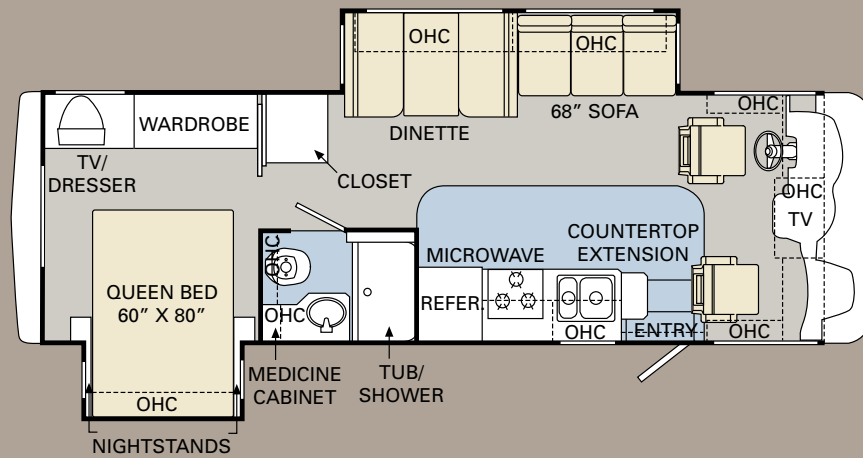

30PDD

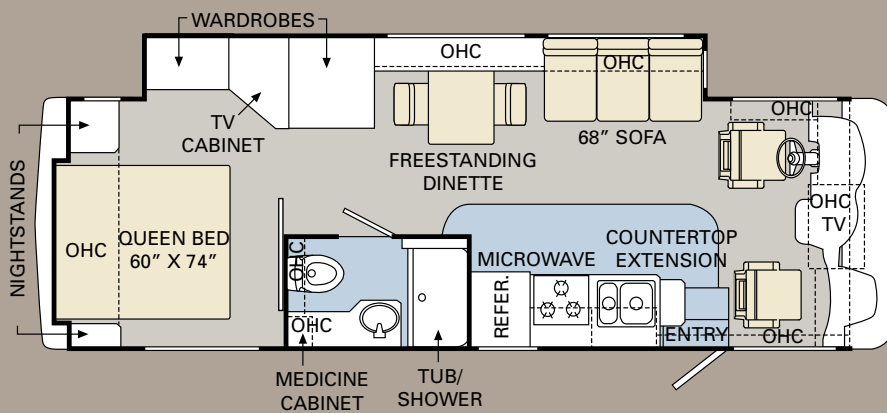

30SFS

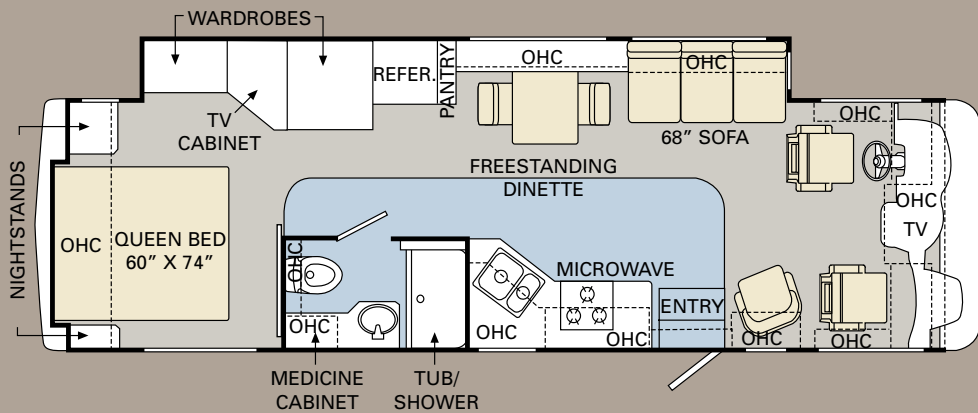

33SFS

TILE CARPET

Ready to choose? The Monarch is available in five thoughtfully designed floorplans from 30 to 35 feet. You can even choose from three PanaSuite™ full-wall slide floorplans for greater livability and uninterrupted living space on the driver's side of the coach.

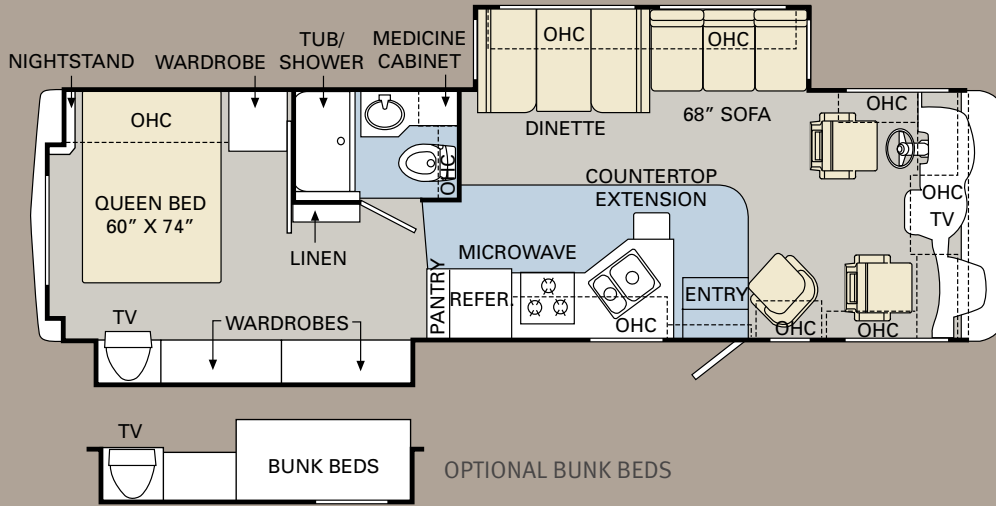

34SBD

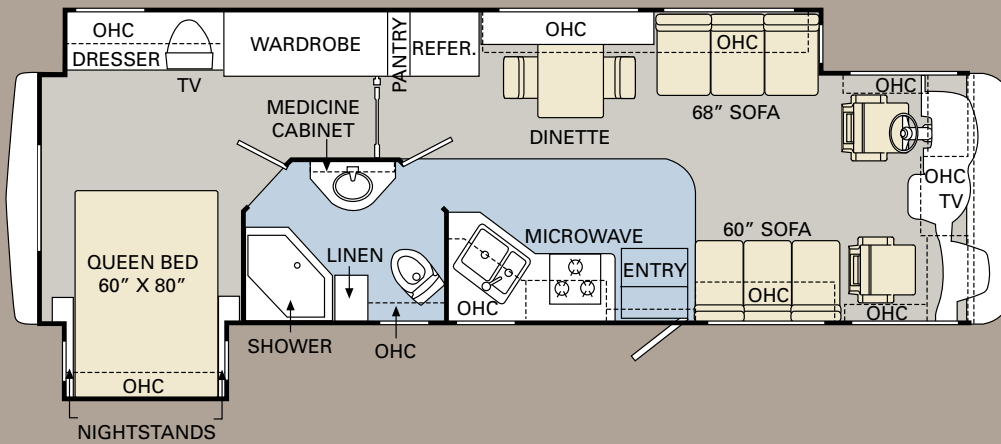

35SFD

ALL ROADS LEAD TO WWW.MONACOCOACH.COM.

Wherever the road takes you, you're never more than a click away from your friends at Monaco. Just go to www.monacocoach.com for all the latest product news, club dates and destinations, a dealer locator function, and factory tour information. You can also e-mail us directly through the site at any time.





SPECIFICATIONS

Due to continuous product improvement, please see the website for the latest in standards and options, specifications, and technical data. *Go to www.monacocoach.com.*

		Weight Ratings (Lbs.)				Measurements				Tank Capacity (Gal.) ²							
		Gross Vehicle	Gross Combined ¹	Front Gross Axle	Rear Gross Axle	Wheelbase	Overall Length	Overall Height (with A/C) (add 5" for satellite option)	Interior Height	Interior Width	Exterior Width	Water Heater	Gray Tank	Black Tank	Fresh Tank	LP Tank ³	Fuel Tank
30PDD	FORD 20,500 LB. CHASSIS	20,500	25,500	7,500	13,500	190"	31'	12' 6"	84"	94.5"	100.5"	6	54	45	60	20	75
	WORKHORSE 20,700 LB. CHASSIS	20,700	25,700	7,500	13,500	190"	31'	12' 6"	84"	94.5"	100.5"	6	54	45	60	20	75
30SFS	FORD 20,500 LB. CHASSIS	20,500	25,500	7,500	13,500	190"	31'	12' 6"	84"	94.5"	100.5"	6	54	45	60	20	75
	WORKHORSE 20,700 LB. CHASSIS	20,700	25,700	7,500	13,500	190"	31'	12' 6"	84"	94.5"	100.5"	6	54	45	60	20	75
33SFS	WORKHORSE 22,000 LB. CHASSIS	22,000	26,000	8,000	14,500	228"	34' 3"	12' 9"	84"	94.5"	100.5"	6	54	42	60	20	75
34SBD	FORD 22,000 LB. CHASSIS	22,000	26,000	7,500	14,500	228"	35' 2"	12' 9"	84"	94.5"	100.5"	6	57	42	60	20	75
	WORKHORSE 22,000 LB. CHASSIS	22,000	26,000	8,000	14,500	228"	35' 2"	12' 9"	84"	94.5"	100.5"	6	57	42	60	20	75
35SFD	FORD 22,000 LB. CHASSIS	22,000	26,000	7,500	14,500	228"	N/A	12' 9"	84"	94.5"	100.5"	6	57	42	60	20	75
	WORKHORSE 22,000 LB. CHASSIS	22,000	26,000	8,000	14,500	228"	N/A	12' 9"	84"	94.5"	100.5"	6	57	42	60	20	75

¹Towing capacity is limited by GCWR; your vehicle's towing capacity is the difference between the GCWR and the actual vehicle weight, including all water, fuel, passengers and cargo. Your towed vehicle should be equipped with auxiliary brakes if the weight of the towed vehicle exceeds 1,000 lbs. Consult your owner's manual for further towing information.

²All tank capacities are estimated based upon calculations provided by the tank manufacturers and represent approximate capacities. The actual "usable capacity" may be greater or less than the estimated capacities based upon fabrication and installation of the tanks.

³Actual filled LP capacity is 80% of listing due to safety shut-off required on tank.

The actual overall length of the recreational vehicle may differ from that indicated in the brochure due to variances in the manufacturing process and/or installed components. The actual length may be greater or less than that indicated. Due to the large variety of options and floorplan arrangements available to our customers, actual weights for each unit can differ significantly. Monaco Coach provides a weight sticker on each unit we produce which includes that unit's tank capacities and approximate weight. Consult your local Monaco Coach dealer for unit availability and further information. The information printed in this brochure reflects product design, fabrication, and component parts at the date of printing. The manufacturer reserves the right, at any time, to make changes in product design or material or component specifications as its sole option, without notice. This

includes the substitution of components of a different brand or trade name which will result in comparable performance. All information printed in this brochure is subject to change after the date of printing. Some features shown or mentioned in this brochure are optional and may only be available in selected floorplans. Photographs may show props or decorations that are not standard equipment on Monaco Coach models. Monaco Coach, the Monaco logo and its design, are registered trademarks. All other products and company names are trademarks and/or registered trademarks of their respective holders. While the color of the motorhome's exterior and the interior fabrics depicted in this sales brochure are fair and reasonable depictions, the colors depicted may not be an exact match of the actual colors because of the variances in photo-processing and variances caused by inserting the photographs

within the sales brochure. **Due to product improvements, changes during the model year and/or transcription errors that may occur, information represented within this brochure may not be accurate at the time of your purchase. If certain information is significant to your purchasing decision, please confirm the information with your dealer prior to submitting your order.** Component part and appliance manufacturers issue limited warranties covering those portions of the recreational vehicle not covered by the Limited Warranties issued by Monaco Coach Corporation. To learn which specific component parts and appliances are excluded from the Limited Warranties issued by Monaco Coach Corporation, please contact your selling dealership or Monaco Coach Corporation directly, or review the warranty packet inside the recreational vehicle.

BODY CONSTRUCTION

- › Alumaframe® Superstructure
- › Steel Cage Cockpit Construction
- › Smooth Gel Coat Fiberglass Exterior
- › New Front Molded Fiberglass Caps
- › Panaview™ 1-Piece Front Windshield
- › New Large Chrome Front Grille
- › New Rear Cap with New Automotive Style Taillights
- › Interior Height 84"
- › One-Piece Interior Engine Cover
- › Power Heated Remote Exterior Mirrors
- › Metal Fuel Door with Lock
- › 30" Deep Bedroom Slide-Out Houses (N/A: 30SFS, 33SFS, 34SBD)
- › One-Piece Polyethylene Pass-Through Storage Compartment
- › Side-Hinged Baggage Doors; All Door Locations
- › Full-Body Paint with Vinyl Graphics
- › Rear Ladder
- › Undercoating

OPTIONS

- › Film Front Mask
- › Standard Run Savings Package: Film Front Mask, Power Sunvisors, Hardwood Raised Panel Doors on Refrigerator, 50 Amp Energy Management System, Patio Awning (33SFS, 34SBD, 35SFD)
- › Standard Run Savings Package: Film Front Mask, Power Sunvisors, Hardwood Raised Panel Doors on Refrigerator, 15M BTU Air Conditioner with Heat Pump, Patio Awning (30SFS, 30PDD only)



FORD 20,500 LB. CHASSIS/ENGINE/SUSPENSION (30PDD, 30SFS ONLY)

- › 6.8L 3-Valve V-10 Gasoline Engine with Electronic Fuel Injection
- › Engine Displacement: 6.8 Liters 415 Cu. In.
- › Power: 362HP; Torque: 457 lbs./ft. Max. Net
- › TorqShift 5-Speed Automatic Overdrive Transmission with Tow/Haul Mode
- › New Transmission Oil Temperature Gauge
- › Fuel Tank Capacity 75 Gallon
- › 130 Amp Alternator
- › Rear Axle Ratio: 5.38:1
- › Radial Tires: 245/70R x 19.5F
- › Stainless Steel Wheel Liners
- › Leaf Spring Suspension
- › Front and Rear Disc, 4-Wheel Anti-Lock Brakes
- › Heavy-Duty Front Track Bar with Bilstein® Shock Absorbers
- › Prewire for Supplemental Braking System
- › 5,000 Lbs. Hitch Receiver with Dual Connector 4-Pin or 7-Pin
- › SmartStructure II

WORKHORSE 20,700 LB. CHASSIS/ENGINE/SUSPENSION (30PDD, 30SFS ONLY)

- › 8.1L V-8 Gasoline Engine with Electronic Fuel Injection
- › Engine Displacement: 8.1 Liters 496 Cu. In.
- › Power: 340HP; Torque: 455 lbs./ft. Max. Net
- › 6-Speed Automatic Transmission with Overdrive
- › Fuel Tank Capacity 75 Gallon
- › 145 Amp Alternator
- › Rear Axle Ratio 5.13:1
- › Radial Tires: 245/70R x 19.5F
- › Stainless Steel Wheel Liner
- › Leaf Spring Suspension
- › ABS Brake System
- › Prewire for Supplemental Braking System
- › 5,000 Lb. Hitch Receiver with Dual Connector 4-Pin or 7-Pin
- › SmartStructure II

FORD 22,000 LB. CHASSIS/ENGINE/SUSPENSION (34SBD, 35SFD ONLY)

- › 6.8L 3-Valve V-10 Gasoline Engine with Electronic Fuel Injection
- › Engine Displacement: 6.8 Liters 415 Cu. In.
- › Power: 362HP; Torque: 457 lbs./ft. Max. Net
- › TorqShift 5-Speed Automatic Overdrive Transmission with Tow/Haul Mode
- › New Transmission Oil Temperature Gauge
- › Fuel Tank Capacity 75 Gallon
- › 130 Amp Alternator
- › Rear Axle Ratio: 5.38:1
- › Radial Tires: 235/80R/22.5G
- › Wheel/Rims Polished Aluminum Wheels
- › Leaf Spring Suspension
- › Front and Rear Disc, 4-Wheel Anti-Lock Brakes
- › Heavy-Duty Front Track Bar with Bilstein® Shock Absorbers
- › Fully Automatic Hydraulic Leveling System
- › Prewire for Supplemental Braking System
- › 5,000 Lb. Hitch Receiver with Dual Connector 4-Pin or 7-Pin
- › SmartStructure II

WORKHORSE 22,000 LB. CHASSIS/ENGINE/SUSPENSION (33SFS, 34SBD, 35SFD ONLY)

- › 8.1L V-8 Gasoline Engine with Electronic Fuel Injection
- › Engine Displacement: 8.1 Liters 496 Cu. In.
- › Power: 340HP; Torque: 455 lbs./ft. Max. Net
- › 6-Speed Automatic Transmission with Overdrive
- › Fuel Tank Capacity 75 Gallon
- › 145 Amp Alternator
- › Rear Axle Ratio: 5.86:1
- › Radial Tires: 235/80R/22.5G
- › Stainless Steel Wheel Liners
- › Leaf Spring Suspension
- › ABS Brake System
- › Fully Automatic Hydraulic Leveling System
- › Prewire for Supplemental Braking System
- › 5,000 Lb. Hitch Receiver with Dual Connector 4-Pin or 7-Pin
- › SmartStructure II

COCKPIT

- › New Fiberglass Automotive Dash with Vinyl Covering, with Silver Graphite Metallic Instrument Panel
- › CD Player/Radio with Sirius-Ready Compatibility, Weather Band and Six Speakers
- › Multi-Positioned Sunvisors
- › Rear Vision System Prep
- › Leatherette Pilot and Co-Pilot Cockpit Recliner Seats
- › Carpeted Driver and Passenger Floor Mats

OPTIONS

- › Sirius Radio Satellite System (Requires Subscription)
- › GPS System High-Speed DVD Navigation System (Requires Rear Vision System Selection)
- › Single Camera Rear Vision System with Audio and Adjustable Camera
- › 3-Camera Rear Vision System with Audio and Adjustable Center Camera
- › Power Sunvisors
- › Interior Solar Privacy Sunscreens (Manual)
- › CB Radio Prep
- › Driver's Side Door with Electric Window

APPLIANCES AND ACCESSORIES

- › Large Double Door Refrigerator 8 Cu. Ft.
- › High-Output 3-Burner Cooktop without Oven
- › Bi-Fold Range Cover
- › Spacesaver Convection Microwave with Touch Control
- › 26" LCD Stereo Color TV with Remote Control in Cockpit Overhead
- › 20" Color TV with Remote Control in Bedroom
- › Curbside Exterior Hook-Ups for DSS Dish, Cable, 110V Outlet with Hatch Door to Exterior
- › Digital Satellite System Prep (Front Cockpit Overhead and Bedroom TV Location)

OPTIONS

- › Large Double-Door Refrigerator with Ice Maker 8 Cu. Ft.
- › Large Double-Door Refrigerator with Ice Maker 10 Cu. Ft.
- › Large Four-Door Refrigerator with Ice Maker (N/A with Pantry) (N/A: 30PDD, 30SFS, 33SFS)
- › High-Output Three-Burner Range with Oven
- › Central Vacuum System
- › Front Living Room Area DVD Player
- › Bedroom DVD Player
- › Exterior Entertainment Center, CD Player/ Radio with Two Speakers

INTERIOR

- › New Profile Raised Panel Cabinet Door Upper Cabinet Doors and Wardrobe Doors with Top Arch
- › Lower Cabinet Doors Squared Flat Panel
- › Black ABS Refrigerator Insert
- › Heavy-Duty Ball-Bearing Drawer Guides
- › Wood Cabinet Drawer Boxes
- › Integrated Cup Holder in Slide-Out next to Sofa
- › Solid Surface Kitchen Countertop with Solid Surface Edge Treatment and Solid Surface Backsplash
- › Kitchen Countertop Extension with Two Drawers below, 110V Outlet under Extension (34SBD)

- › Kitchen Countertop Extension (30PDD, 30SFS)
- › All Other Countertops (except Kitchen) Laminated with Wood Grain Rubber Edge
- › Kitchen Pantry next to Refrigerator with Full-Height Wire Roll-Out Storage (N/A with Four-Door Refrigerator Option) (N/A: 30PDD, 30SFS)
- › Carpeting with Pad in Living Area and Bedroom
- › Soft Touch Padded Vinyl Ceiling
- › Wood Slide-Out Fascia with Fabric Inserts on Header and Legs
- › New Satin Nickel Cabinetry Hardware and Bath Accessories
- › Hardwood Framed Pocket Doors with Flat Panel Insert (N/A: 35SFD)

- › Blackout Day/Night Pleated Shades in Living Area and in Bedroom
- › Soil Repellant on Fabric, Teflon® Fabric Protection (Living Room Fabrics)

OPTIONS

- › New Decors: Rembrandt and Urban Loft
- › Wood Choice: Newport Cherry, Champagne Select
- › Hardwood Raised Panel Doors on Refrigerator IPO Black ABS Refrigerator Insert

FURNITURE

- › Queen Bed with Nightstands (60" x 74" 30SFS, 33SFS, 34SBD) (60" x 80" 30PDD, 35SFD)
- › Arched Back Wood Booth Dinette with Side-Sliding Dinette Tabletop (N/A: 30SFS, 33SFS, 35SFD)
- › Freestanding Dinette with Two Freestanding Chairs and Two Folding Chairs (N/A: 30PDD, 34SBD)
- › Roadside: New Style Fabric Easy Bed Sofa
- › Curbside: New Style Fabric Love Seat (35SFD Only)
- › New Style Leatherette Swivel-Rocker Barrel Chair (33SFS, 34SBD)

OPTIONS

- › Roadside: Fabric Hide-A-Bed Sofa
- › Roadside: Fabric Hide-A-Bed Sofa with Air Mattress
- › Roadside: Leatherette Hide-A-Bed Sofa with Air Mattress
- › Roadside: Leatherette Ensemble Booth Dinette Includes Leatherette Hide-A-Bed Sofa Selection with Air Mattress
- › Forward-Facing Seatbelts at Booth Dinette Location N/A with this Option (34SBD Only)
- › Curbside: New Style Leatherette Love Seat IPO Fabric Love Seat (35SFD Only)
- › Curbside: New Style Leatherette Swivel Recliner (33SFS, 34SBD Only)
- › Curbside: Leatherette Euro-Recliner Chair with Ottoman (33SFS, 34SBD Only)
- › Hallway Bunks with Bottom Drawers, 20" LCD TV with AV Game Plate (34SBD Only)
- › Freestanding Dinette with Two Freestanding Chairs and Two Folding Chairs (34SBD Only)



ELECTRICAL SYSTEMS AND LIGHTS

- › 30 Amp 120V Distribution Panel and Cord (30PDD, 30SFS)
- › 50 Amp 120V Distribution Panel and Cord (33SFS, 34SBD, 35SFD)
- › 60 Amp Electronic 12V Power Converter
- › Onan® 4.0 kW Gas Generator (30PDD, 30SFS)
- › Onan® 5.5 kW Gas Generator (Gold Advantage)
- › Two 6V House Batteries
- › Battery Disconnect Switches
- › Exterior Power Entry Step with Light
- › Water Pump Switch in Service Bay Area and Convenience Center
- › Lights in Outside Storage Compartments
- › Underhood Utility Light
- › Two Recessed Ceiling Map Lights above Cockpit Seats, One Pilot Side and One Co-Pilot Side
- › Hallway Convenience Center

- › Three Recessed Ceiling Lights above Countertop Work Area Kitchen
- › Decorative Satin Nickel Lighting, Living Room Wall Light

OPTIONS

- › 50 Amp Energy Management System (N/A: 30PDD, 30SFS)

PLUMBING AND LP SYSTEMS

- › New Kitchen Faucet, Two-Hole Hi-Rise Faucet with Soap Dispenser
- › Central Water Filtration System
- › Satin Nickel Bath Lavatory Faucet
- › Demand Water System and Water Pump
- › 6-Gallon LP Gas/Electric Water Heater with Electronic Ignition
- › Winterization Valving System
- › Water Heater Bypass Valve
- › China Toilet with Sprayer
- › No-Fuss Flush Holding Tank Rinsing System
- › Insulated Systems Compartment with Easy Access to Hook-Up
- › Shower inside Wet Bay with Hot/Cold Water; Shower Head with Shut-Off
- › Soap Dispenser inside Utility Bay
- › Gravity and Pressurized Water Fill (N/A: 35SFD)
- › Contained Storage Area for Sewer Hose
- › Shower Faucet with Shower Hose and Head with Shut-Off

OPTIONS

- › RV Sani-Con 2 System, Holding Tank Flush System with Hanging Bracket for Hose
- › 10-Gallon LP Gas/Electric Water Heater with Electronic Ignition
- › Bathtub IPO Shower

HEATING, VENTS AND AIR CONDITIONING

- › Dual 13.5M BTU Air Conditioner with Ducted Air and Wall Thermostats (33SFS, 34SBD, 35SFD)
- › Single 13.5M BTU Air Conditioner with Ducted Air and Wall Thermostats (30SFS, 30PDD)
- › 31M BTU Electronic Ignition Furnace (30PDD, 30SFS)
- › 35M BTU Electronic Ignition Furnace (33 SFS, 34SBD, 35SFD)
- › Kitchen 12V Roof Vent
- › Bath 12V Roof Vent

OPTIONS

- › Dual 15M BTU Air Conditioner with Heat Pumps (33SFS, 34SBD, 35SFD)
- › Single 15M BTU Air Conditioner with Heat Pumps (30SFS, 30PDD)

- › Kitchen Powered Attic Fan with Wall Control of Automatic Dome and Fan Power
- › Bath Powered Attic Fan with Wall Control of Automatic Dome and Fan Power
- › 12V Heater in Wet Bay, Heat Pad on Fresh Tank

WINDOWS, DOORS AND AWNINGS

- › Radius Flush-Mounted Dual Pane Windows Safety Glass Dark Tinted (Atwood)
- › Rear Wall Bedroom Window (N/A: 30SFS, 33SFS)
- › Bathroom Window (35SFD Only)
- › Radius Entrance Door with Clear Glass, Roller Shade, Screen Door and Anti-Skid Steps
- › Topper Slide-Out Awnings Living Area and Bedroom
- › Protecta Glaze Tinted Plexiglas® Skylight in Bathroom
- › Awning Rail

OPTIONS

- › Patio Awning with Metal Cover
- › Eclipse Poly-Weave Automatic Patio Awning with Metal Cover
- › Poly-Weave Window Awnings Living Area Slide-Out House Windows (except Kitchen Windows) (Living Area Slide-Out Window Awning for Sofa and Dinette, One Awning over Both Windows)
- › Poly-Weave Side Window Awning Bedroom (30PDD, 30SFS, 33SFS)

SAFETY

- › Fire Extinguisher (10BC)
- › Deadbolt Lock on Entrance Door
- › 120V GFI Protected Circuit, Kitchen, Bath and Exterior
- › LP Gas Detector
- › Smoke Detector
- › Carbon Monoxide Detector
- › Pilot and Co-Pilot Three-Point Seatbelts (Lap and Shoulder)
- › Third Brake Safety Light
- › Egress Window(s)

BEING DIFFERENT MAKES ALL THE DIFFERENCE.

At Monaco, we always strive to be the best. And that means thinking outside the box. Giving you more of what you want in an RV. Like our exclusive Roadmaster chassis. Three factory-owned service centers. And programs like Monaco Financial Services and 24/7 roadside assistance. No other manufacturer can match Monaco's offerings. No one even comes close. Why not discover the difference for yourself? Go Monaco.

“No other manufacturer can match Monaco's offerings. No one even comes close.”

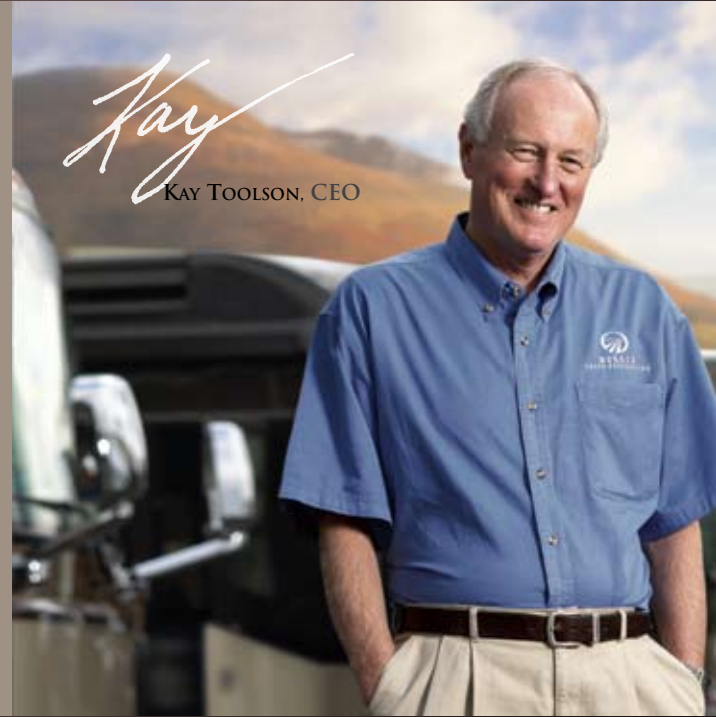

www.monacodifferent.com | 877-252-4666

DEALER:



MONACO®

DRIVING YOUR DREAM.

91320 Coburg Industrial Way, Coburg, OR 97408 | 800 634-0855

www.monacocoach.com